

P4

rén

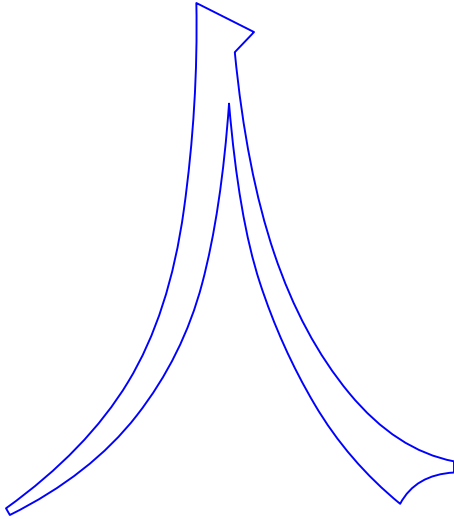

dà

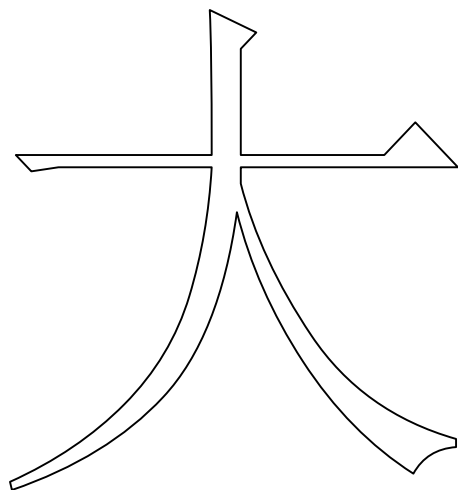

xiǎo

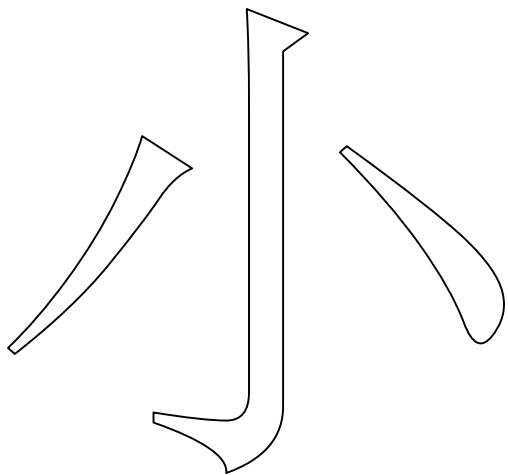

xiǎo

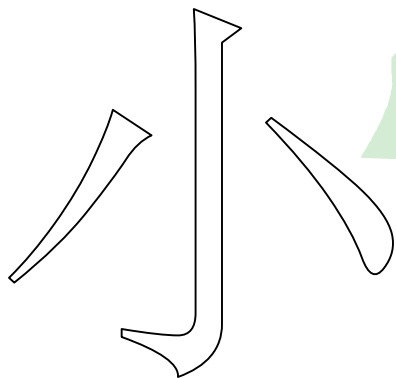

dà

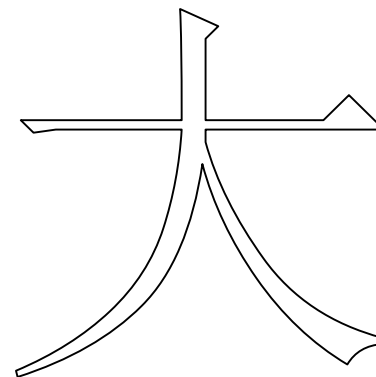

xiǎo rén

小人

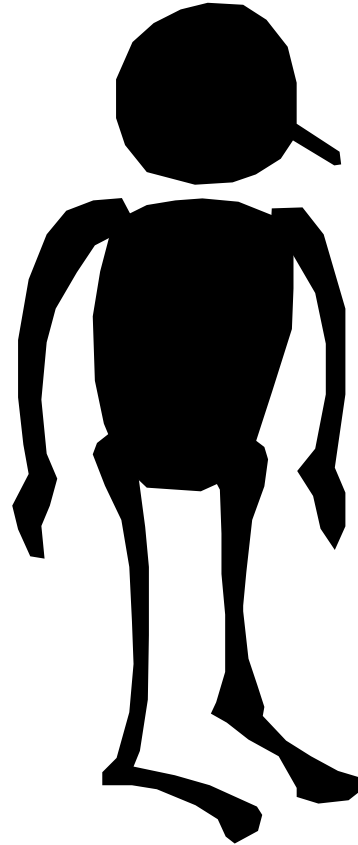
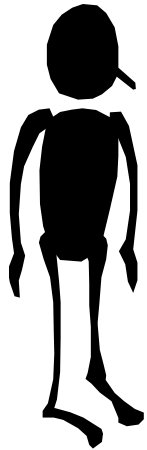

dà rén

大人

cóng

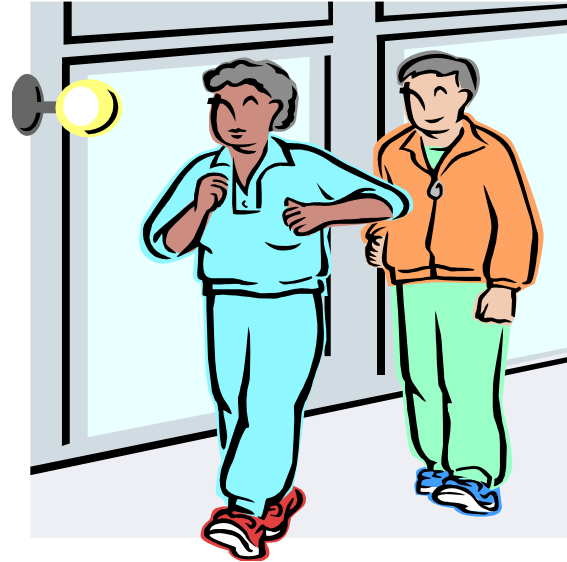
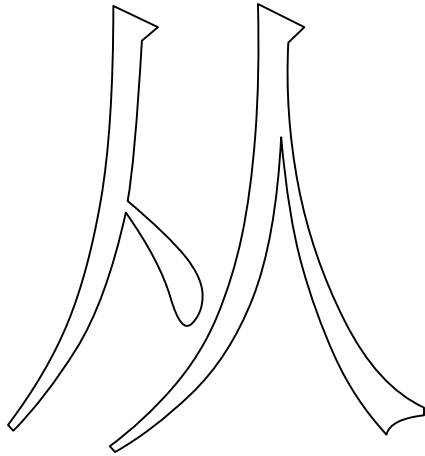

zhòng

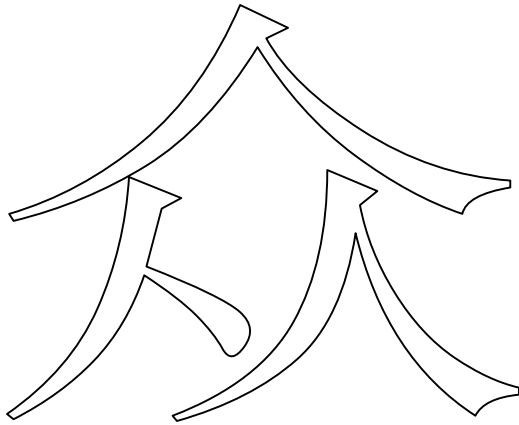

jiān

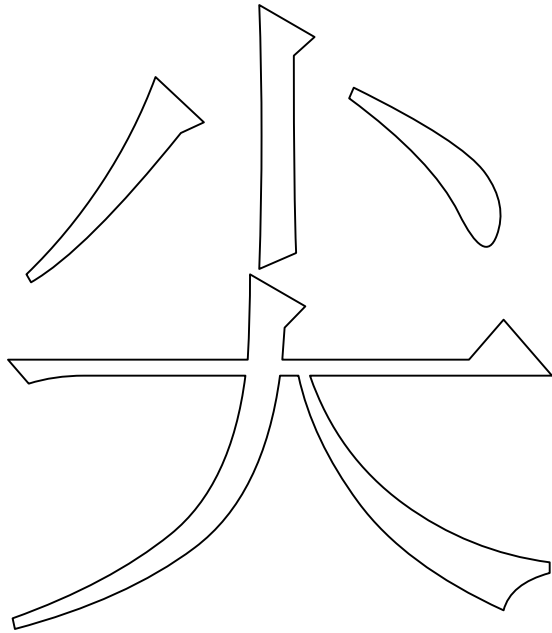

tiān

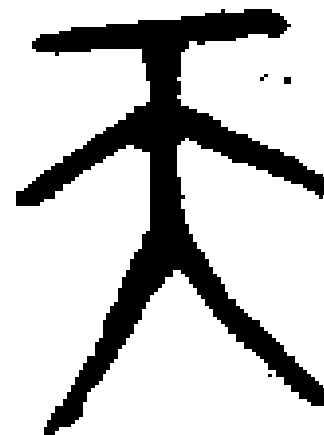
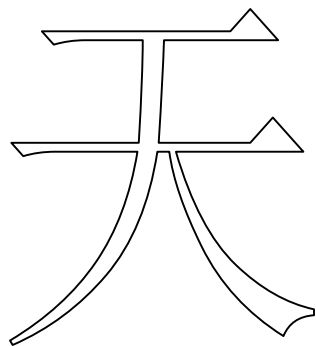

fū

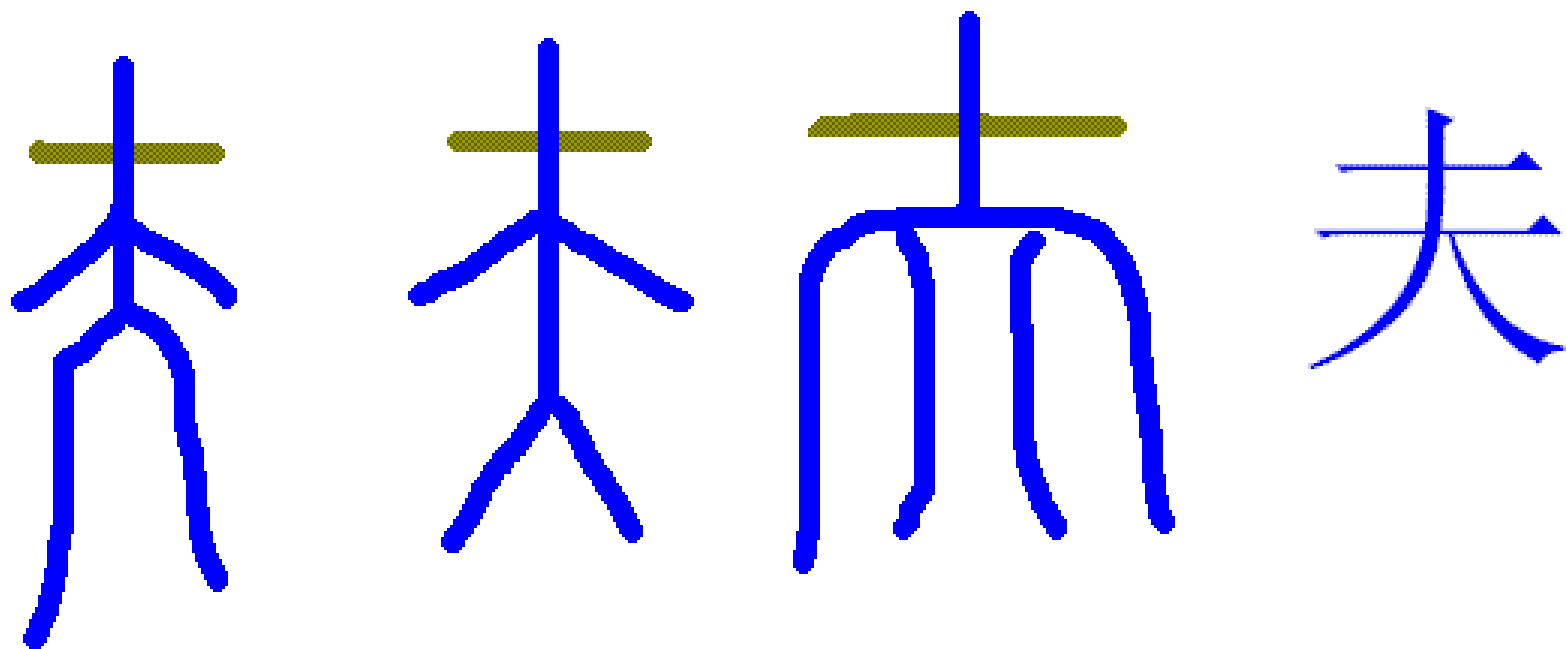

夫，会意字。大是人，大之上作一横贯穿头发，这一横就是发簪。古时男子成年之后才能把头发挽在头上，别上发簪、戴上帽子，所以夫的本义是成年男子。引申指女子的配偶，也作男子的美称。成语：夫唱妇随。形近字：天。夫作偏旁的字：扶、肤、规等。



shān





tián

田



力



力

力



力

nán

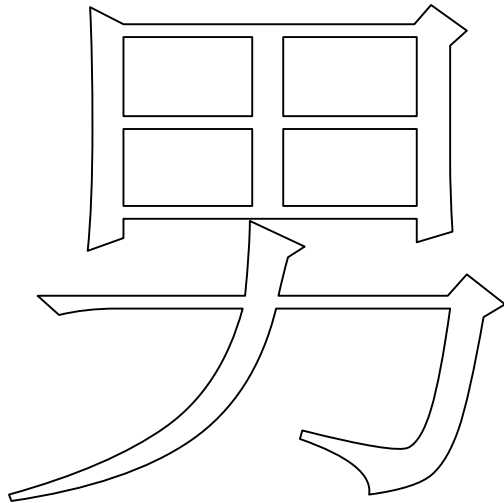

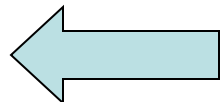
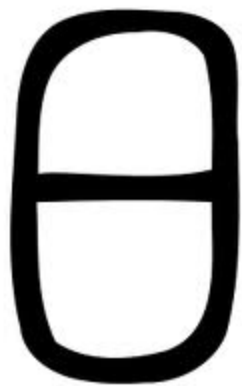
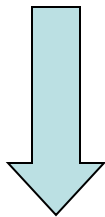
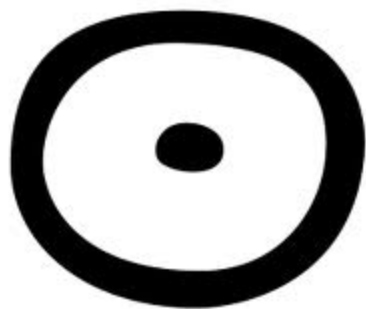

rì

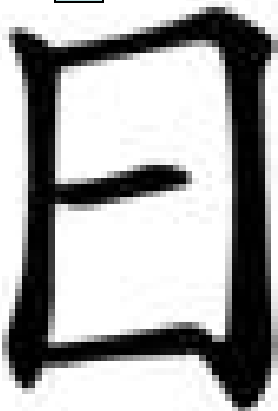

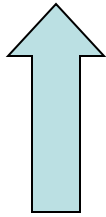
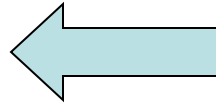
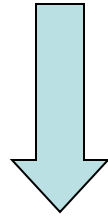

yuè

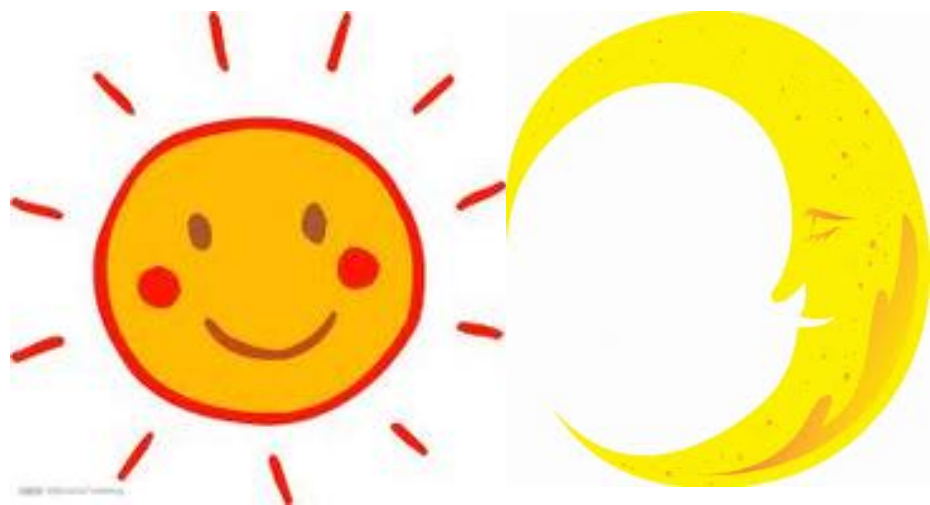

míng

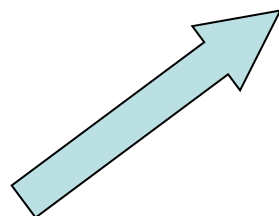
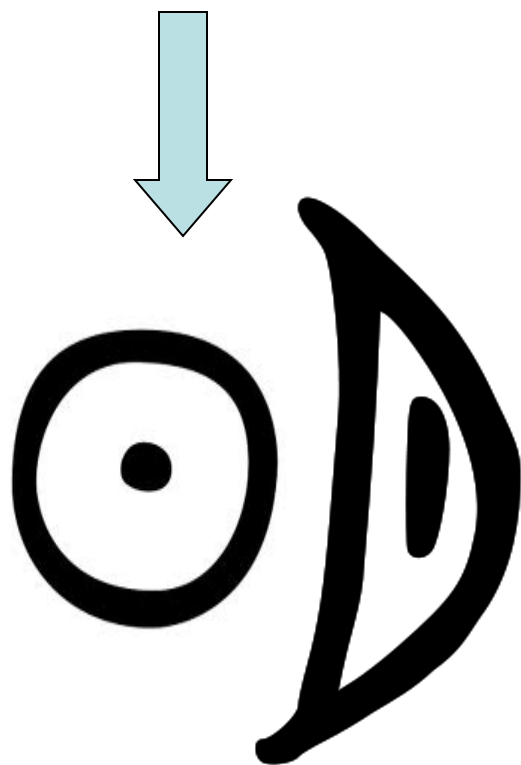
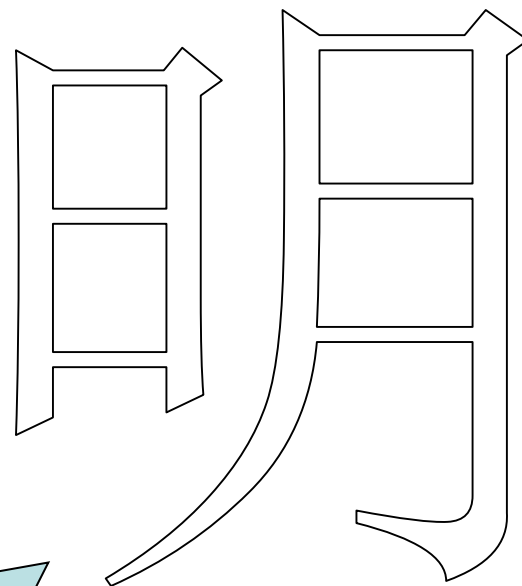

shàng

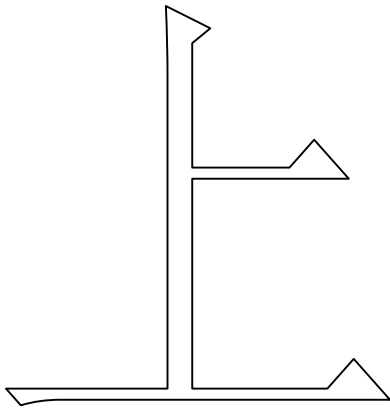

xià

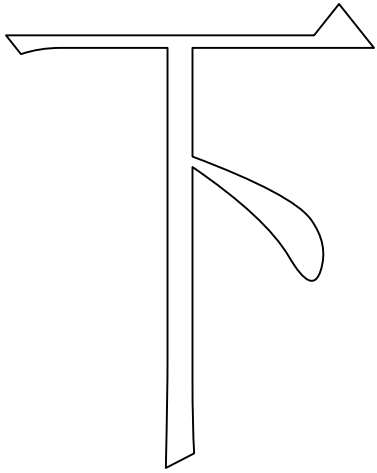



上

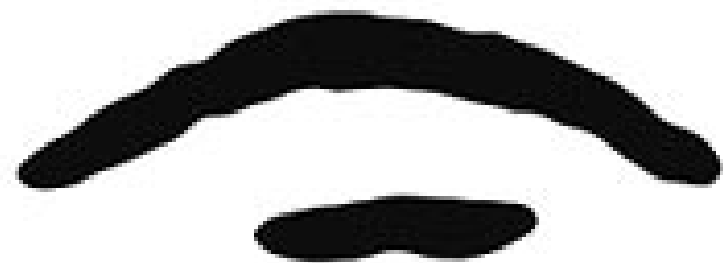

下

dàn

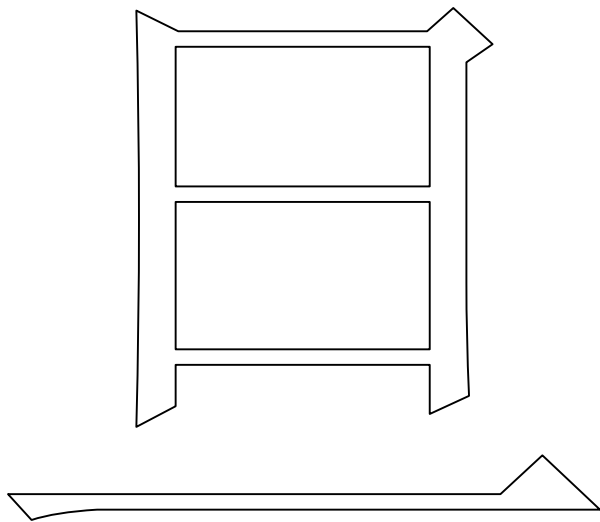

dàn

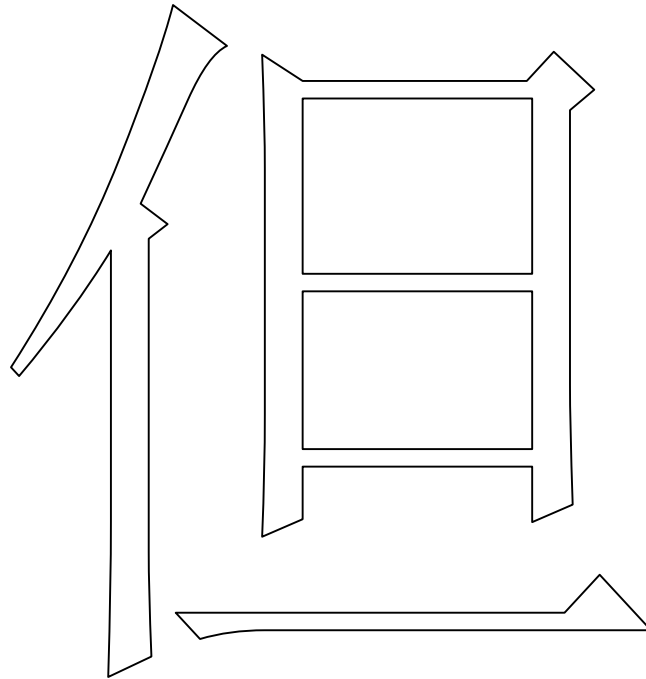

zǎo

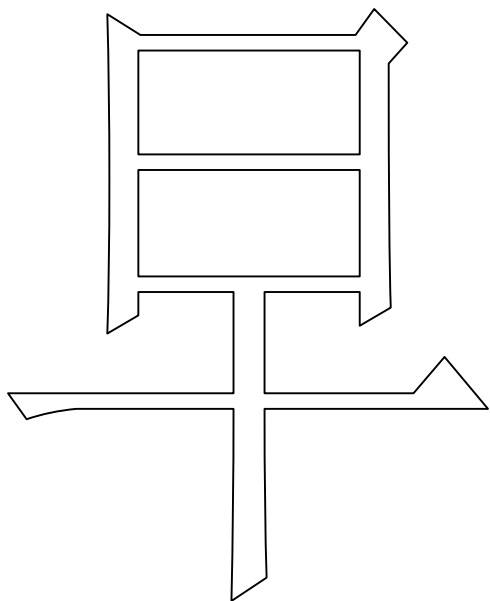

AM

kǒu



口

𠮩

chū kǒu

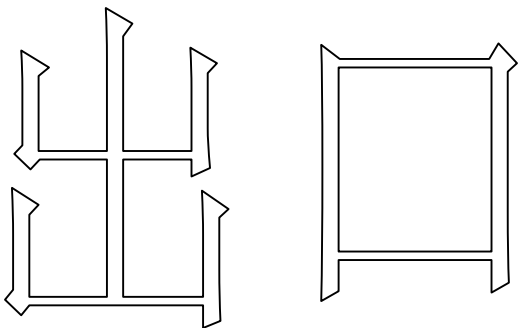

chàng

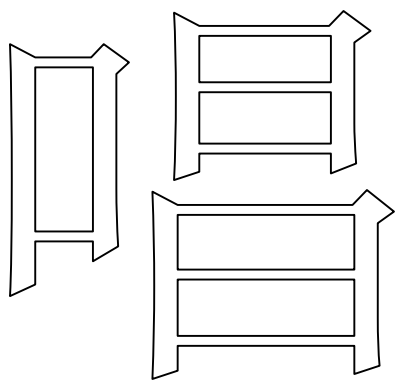

qiú

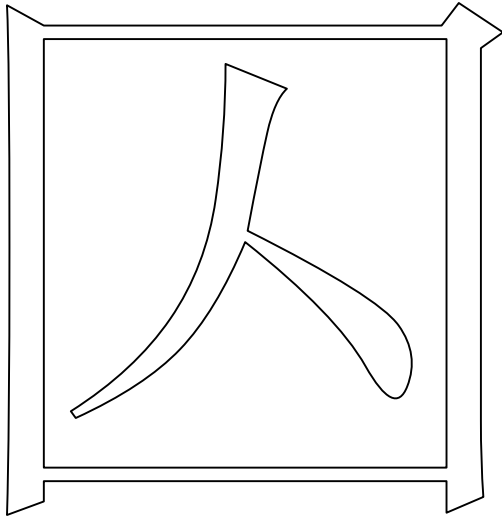

mù

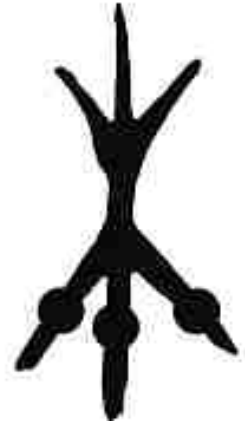
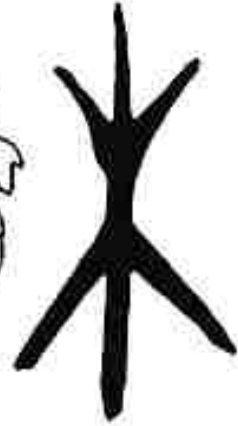
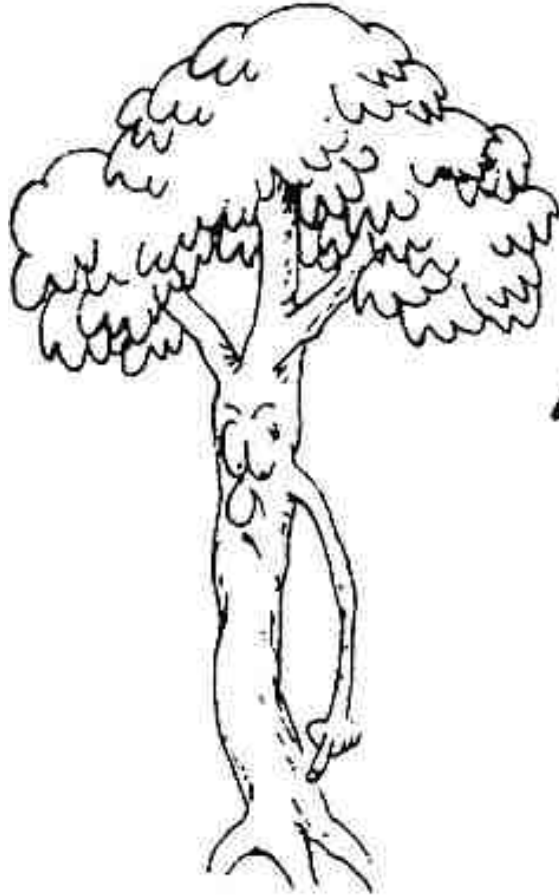
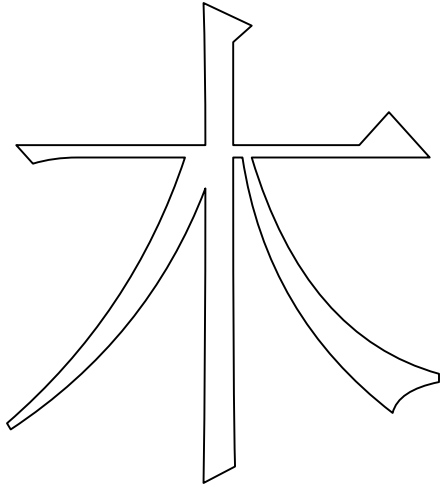

lín

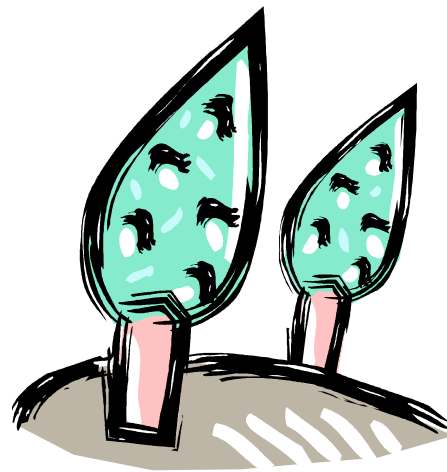
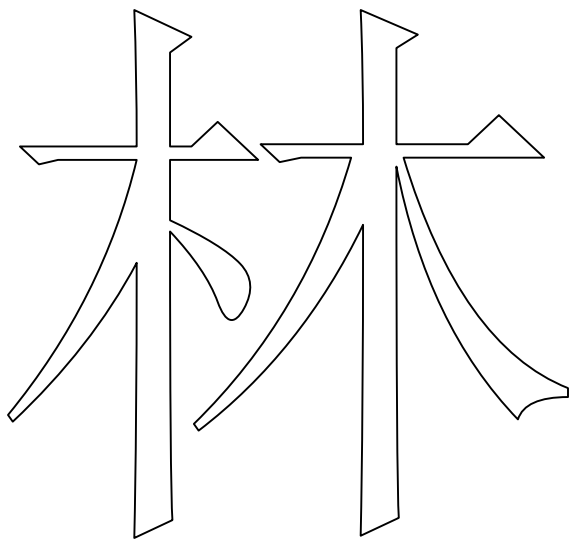

sēn

森



xiū

